



## LM382 Low Noise Dual Preamplifier

### General Description

The LM382 is a dual preamplifier for the amplification of low level signals in applications requiring optimum noise performance. Each of the two amplifiers is completely independent, with individual internal power supply decoupler-regulator, providing 120 dB supply rejection and 60 dB channel separation. Other outstanding features include high gain (100 dB), and wide power bandwidth (75 kHz, 20 Vp-p). The LM382 operates from a single supply across the wide range of 9V to 40V.

A resistor matrix is provided on the chip to allow the user to select a variety of closed loop gain options and frequency response characteristics such as flat-band, NAB or RIAA equalization. The circuit is supplied in the 14 lead dual-in-line package.

### Features

- Low noise — 0.8  $\mu\text{V}$  total equivalent input noise
- High gain — 100 dB open loop
- Single supply operation
- Wide supply range 9V to 40V
- Power supply rejection — 120 dB
- Large output voltage swing
- Wide bandwidth — 15 MHz unity gain
- Power bandwidth — 75 kHz, 20 Vp-p
- Internally compensated
- Short circuit protected

### Schematic and Connection Diagrams

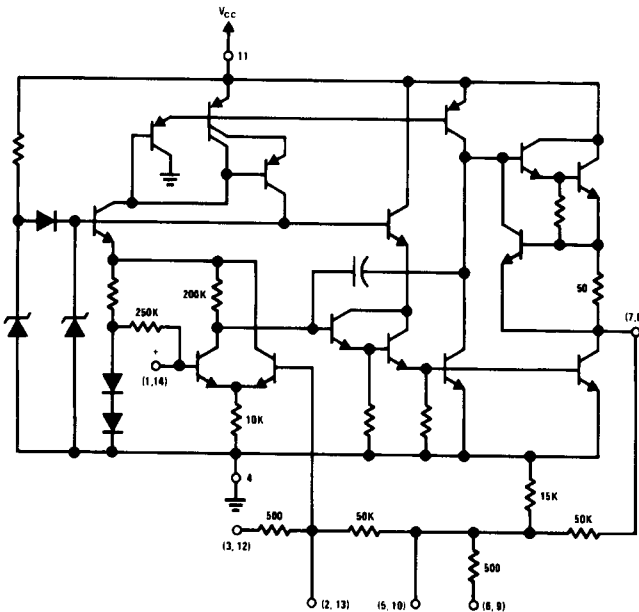

TL/H/7842-1

### Dual-In-Line Package

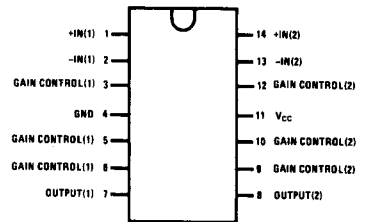

TL/H/7842-2

### Top View

Order Number LM382N  
See NS Package Number N14A

### Absolute Maximum Ratings

If Military/Aerospace specified devices are required, please contact the National Semiconductor Sales Office/Distributors for availability and specifications.

Supply Voltage +40V  
 Power Dissipation (Note 1) 1.56 W

Operating Temperature Range 0°C to +70°C  
 Storage Temperature Range -65°C to +150°C  
 Lead Temperature (Soldering, 10 sec.) +260°C

### Electrical Characteristics $T_A = 25^\circ\text{C}$ , $V_{CC} = 14\text{V}$ , unless otherwise stated.

Parameter	Conditions	Min	Typ	Max	Units
Voltage Gain	Open Loop, $f = 100\text{ Hz}$		100,000		V/V
Supply Current	$V_{CC} 9\text{V to }40\text{V}$ , $R_L = \infty$		10	20	mA
Output DC Voltage			6		V
Input Resistance (Positive Input) (Negative Input)			100		k $\Omega$
			200		k $\Omega$
Input Current (Negative Input)			0.5		$\mu\text{A}$
Output Resistance	Open Loop		150		$\Omega$
Output Current	Source		8		mA
	Sink		2		mA
Output Voltage Swing	Peak-to-Peak, $R_L = 10\text{k}$		12		V
Unity Gain Bandwidth			15		MHz
Power Bandwidth	20 Vp-p ( $V_{CC} = 24\text{V}$ )		75		kHz
Maximum Input Voltage	Linear Operation			300	mVrms
Supply Rejection Ratio	$f = 1\text{ kHz}$		120		dB
Channel Separation	$f = 1\text{ kHz}$	40	60		dB
Total Harmonic Distortion	60 dB Gain, $f = 1\text{ kHz}$		0.1	0.3	%
Total Equivalent Input Noise	$R_S = 600\Omega$ , 100-10,000 Hz (Flat Response Circuit)		0.8	1.2	$\mu\text{Vrms}$

Note 1: For operation in ambient temperatures above 25°C, the device must be derated based on a 150°C maximum junction temperature and a thermal resistance of 80°C/W junction to ambient.

### Typical Applications

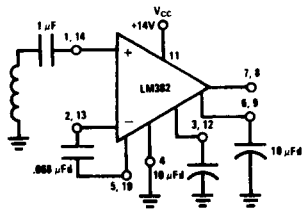

TL/H/7842-3

Tape Preamp (NAB Equalization)

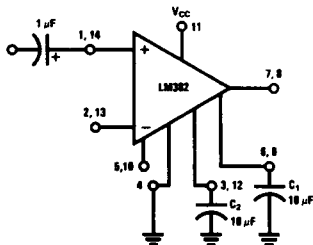

TL/H/7842-5

Flat Response — Fixed Gain Configuration

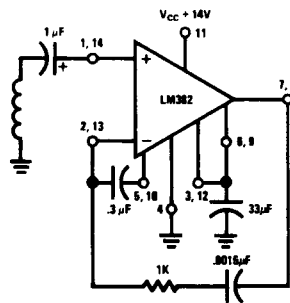

TL/H/7842-4

Phono Preamp (RIAA Equalization)

Capacitor	Gain
C1 Only	40 dB
C2 Only	55 dB
C1 & C2	80 dB

# Typical Performance Characteristics

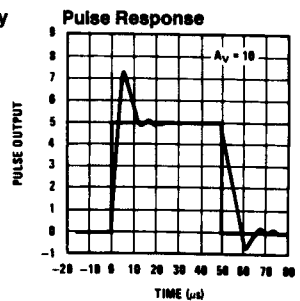
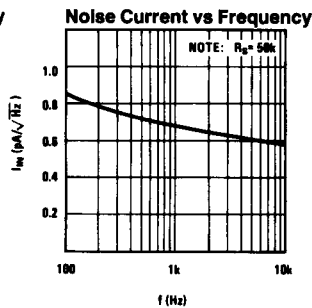
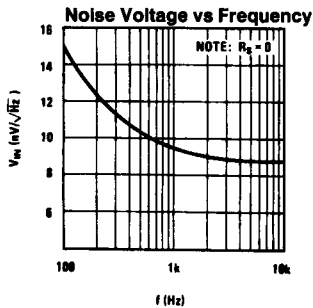
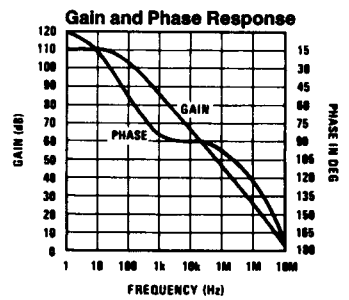
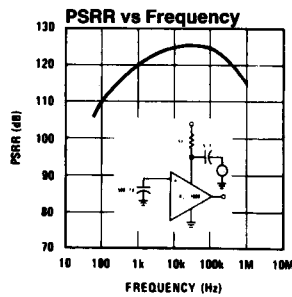
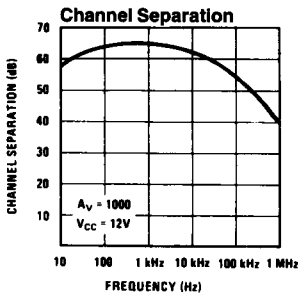
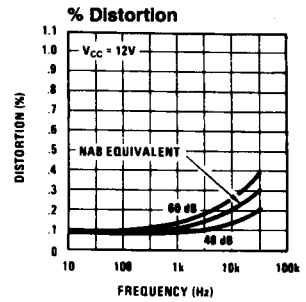
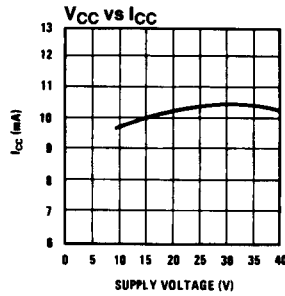
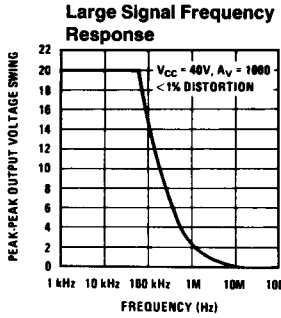

This datasheet has been downloaded from:

[www.DatasheetCatalog.com](http://www.DatasheetCatalog.com)

Datasheets for electronic components.