

# JFET VHF/UHF Amplifiers

## N-Channel — Depletion

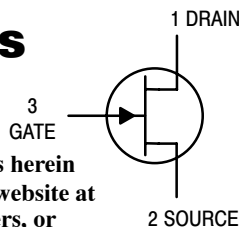

- This device is available in Pb-free package(s). Specifications herein apply to both standard and Pb-free devices. Please see our website at [www.onsemi.com](http://www.onsemi.com) for specific Pb-free orderable part numbers, or contact your local ON Semiconductor sales office or representative.

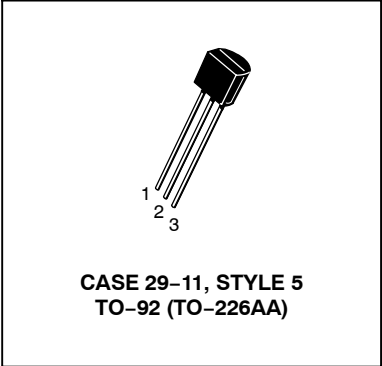

### MAXIMUM RATINGS

Rating	Symbol	Value	Unit
Drain – Gate Voltage	$V_{DG}$	25	Vdc
Reverse Gate – Source Voltage	$V_{GSR}$	25	Vdc
Drain Current	$I_D$	30	mAdc
Forward Gate Current	$I_{G(f)}$	10	mAdc
Total Device Dissipation @ $T_C = 25^\circ\text{C}$ Derate above $25^\circ\text{C}$	$P_D$	350 2.8	mW mW/ $^\circ\text{C}$
Operating and Storage Junction Temperature Range	$T_J, T_{stg}$	-65 to +150	$^\circ\text{C}$

### ELECTRICAL CHARACTERISTICS ( $T_A = 25^\circ\text{C}$ unless otherwise noted)

Characteristic	Symbol	Min	Typ	Max	Unit
----------------	--------	-----	-----	-----	------

#### OFF CHARACTERISTICS

Gate – Source Breakdown Voltage ( $I_G = -1.0 \mu\text{Adc}, V_{DS} = 0$ )	$V_{(BR)GSS}$	-25	—	—	Vdc
Gate Reverse Current ( $V_{GS} = -20 \text{ Vdc}, V_{DS} = 0$ ) ( $V_{GS} = -20 \text{ Vdc}, V_{DS} = 0, T_A = 100^\circ\text{C}$ )	$I_{GSS}$	— —	— —	-1.0 -0.2	nAdc $\mu\text{Adc}$
Gate Source Cutoff Voltage ( $V_{DS} = 15 \text{ Vdc}, I_D = 10 \text{ nAdc}$ )	$V_{GS(off)}$	-2.0	—	-6.0	Vdc

#### ON CHARACTERISTICS

Zero – Gate – Voltage Drain Current ( $V_{DS} = 15 \text{ Vdc}, V_{GS} = 0$ )	$I_{DSS}$	8.0	—	20	mAdc
--	-----------	-----	---	----	------

#### SMALL-SIGNAL CHARACTERISTICS

Forward Transfer Admittance ( $V_{DS} = 15 \text{ Vdc}, V_{GS} = 0, f = 1.0 \text{ kHz}$ )	$ y_{fs} $	4000	—	8000	$\mu\text{hos}$
Input Admittance ( $V_{DS} = 15 \text{ Vdc}, V_{GS} = 0, f = 400 \text{ MHz}$ )	$\text{Re}(y_{is})$	—	—	1000	$\mu\text{hos}$
Output Admittance ( $V_{DS} = 15 \text{ Vdc}, V_{GS} = 0, f = 1.0 \text{ kHz}$ )	$ y_{os} $	—	—	75	$\mu\text{hos}$
Output Conductance ( $V_{DS} = 15 \text{ Vdc}, V_{GS} = 0, f = 400 \text{ MHz}$ )	$\text{Re}(y_{os})$	—	—	100	$\mu\text{hos}$
Forward Transconductance ( $V_{DS} = 15 \text{ Vdc}, V_{GS} = 0, f = 400 \text{ MHz}$ )	$\text{Re}(y_{fs})$	3500	—	—	$\mu\text{hos}$

**ELECTRICAL CHARACTERISTICS** ( $T_A = 25^\circ\text{C}$  unless otherwise noted) (Continued)

Characteristic	Symbol	Min	Typ	Max	Unit
<b>SMALL-SIGNAL CHARACTERISTICS (continued)</b>					
Input Capacitance ( $V_{DS} = 15\text{ Vdc}$ , $V_{GS} = 0$ , $f = 1.0\text{ MHz}$ )	$C_{iss}$	—	—	5.0	pF
Reverse Transfer Capacitance ( $V_{DS} = 15\text{ Vdc}$ , $V_{GS} = 0$ , $f = 1.0\text{ MHz}$ )	$C_{rss}$	—	—	1.0	pF
Output Capacitance ( $V_{DS} = 15\text{ Vdc}$ , $V_{GS} = 0$ , $f = 1.0\text{ MHz}$ )	$C_{oss}$	—	—	2.0	pF

**COMMON SOURCE CHARACTERISTICS**  
**ADMITTANCE PARAMETERS**

( $V_{DS} = 15\text{ Vdc}$ ,  $T_{channel} = 25^\circ\text{C}$ )

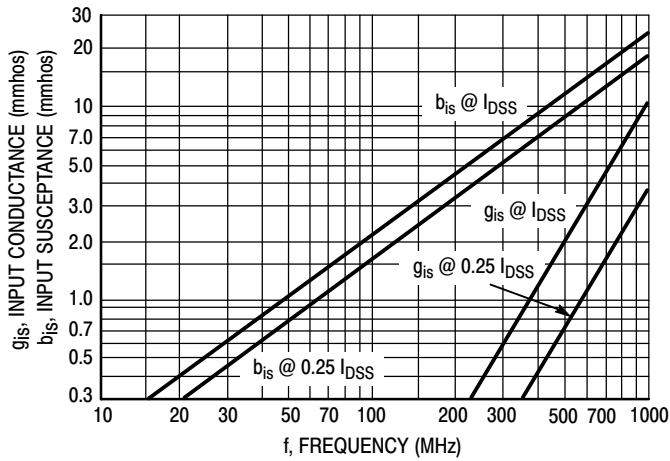

Figure 1. Input Admittance ( $y_{is}$ )

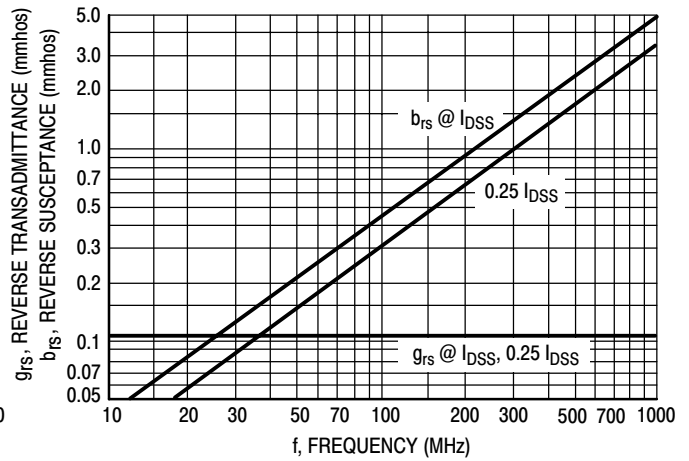

Figure 2. Reverse Transfer Admittance ( $y_{rs}$ )

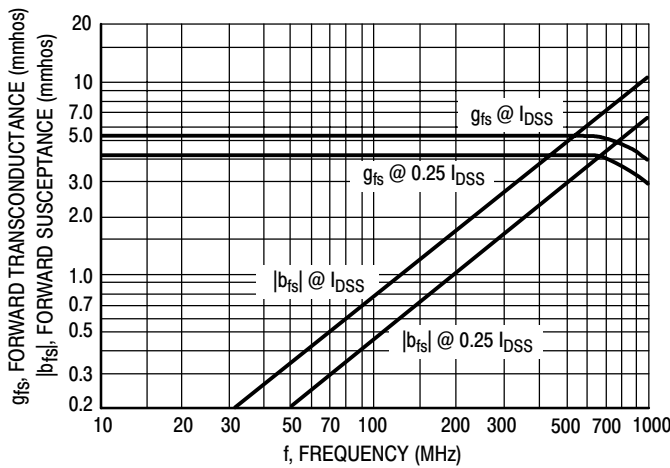

Figure 3. Forward Transadmittance ( $y_{fs}$ )

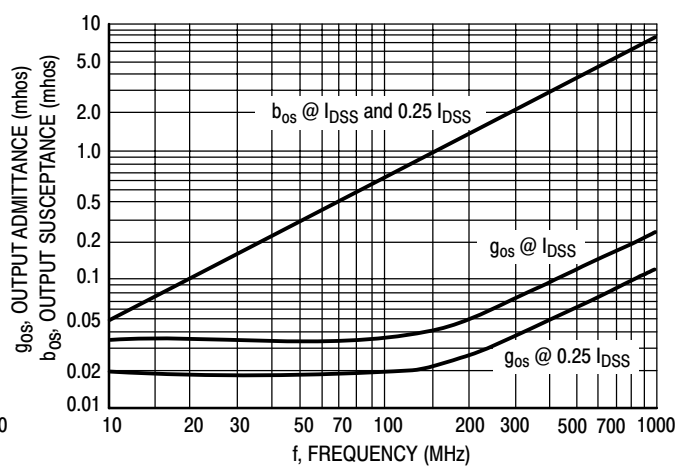

Figure 4. Output Admittance ( $y_{os}$ )

**COMMON SOURCE CHARACTERISTICS**  
**S-PARAMETERS**

( $V_{DS} = 15 \text{ Vdc}$ ,  $T_{channel} = 25^\circ\text{C}$ , Data Points in MHz)

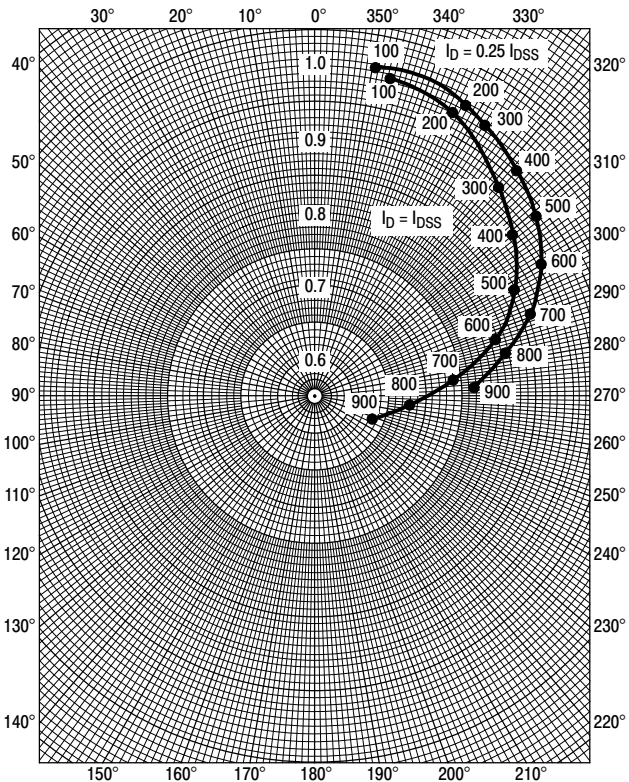

Figure 5.  $S_{11s}$

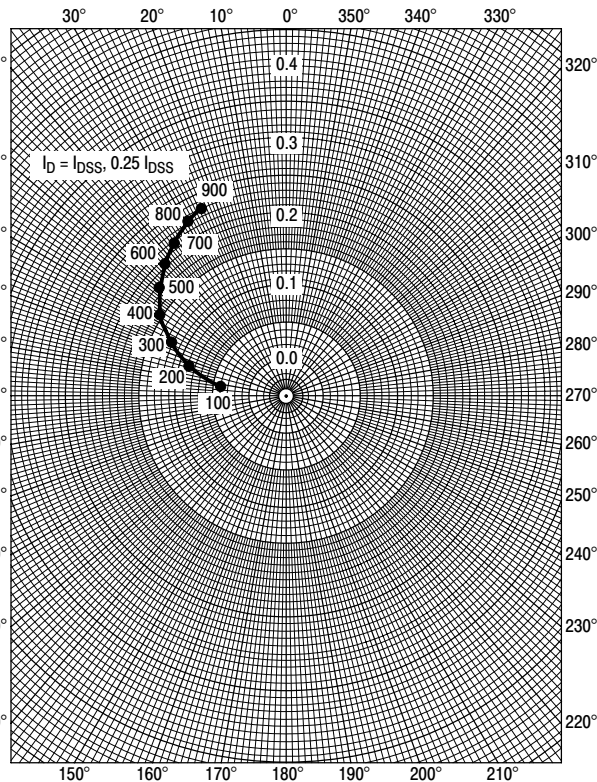

Figure 6.  $S_{12s}$

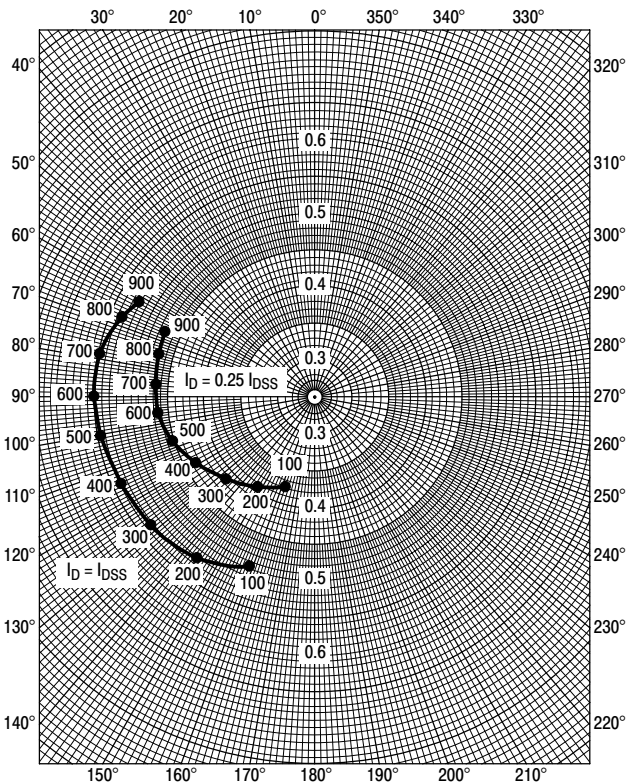

Figure 7.  $S_{21s}$

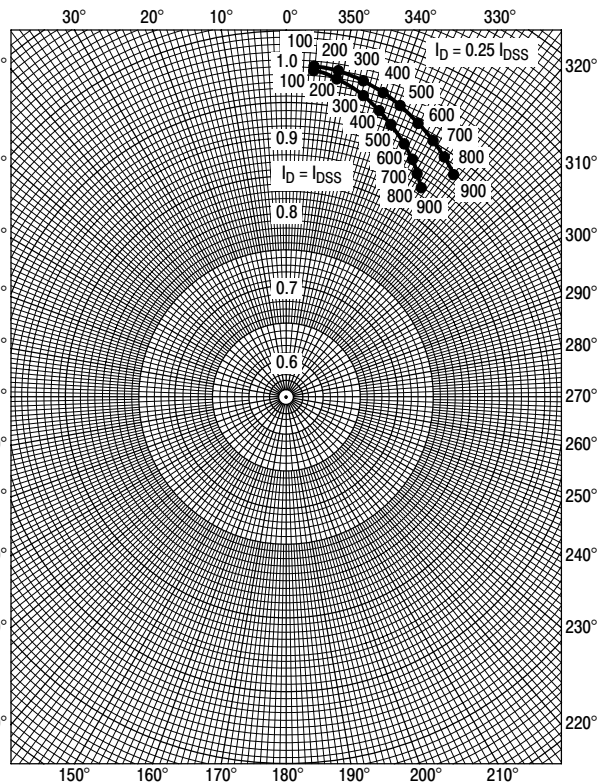

Figure 8.  $S_{22s}$

COMMON GATE CHARACTERISTICS

ADMITTANCE PARAMETERS

( $V_{DG} = 15 \text{ Vdc}$ ,  $T_{channel} = 25^\circ\text{C}$ )

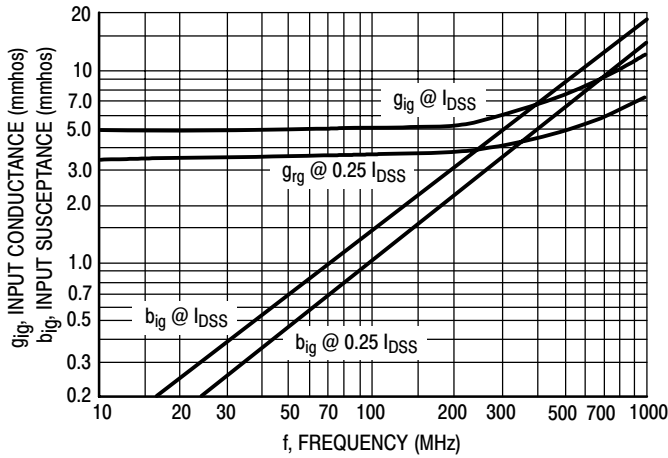

Figure 9. Input Admittance ( $y_{ig}$ )

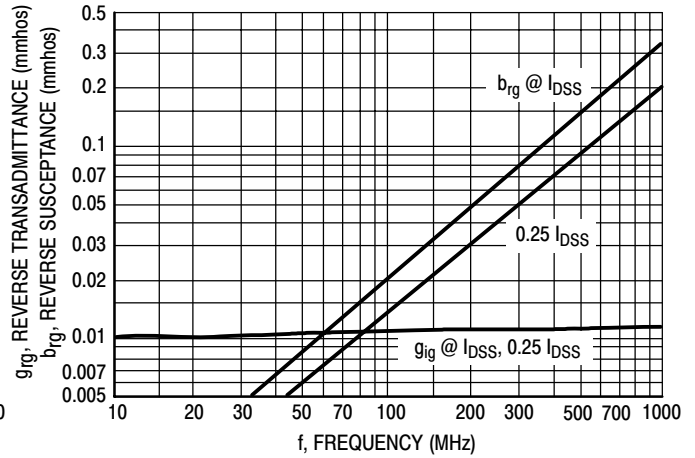

Figure 10. Reverse Transfer Admittance ( $y_{rg}$ )

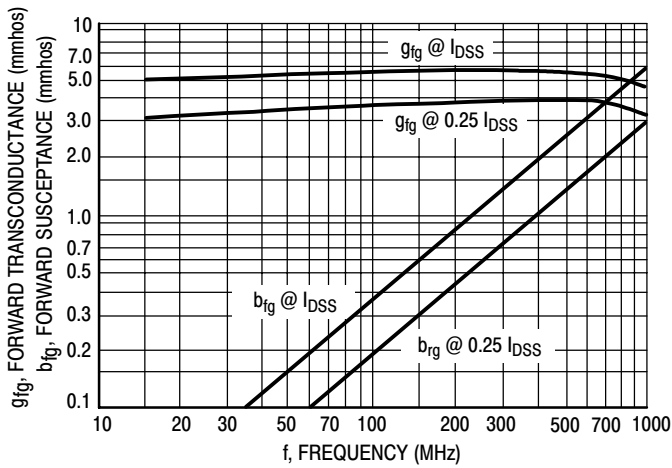

Figure 11. Forward Transfer Admittance ( $y_{fg}$ )

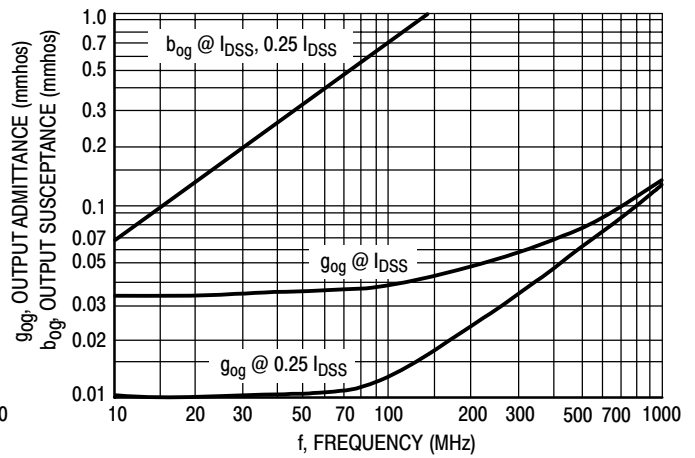

Figure 12. Output Admittance ( $y_{og}$ )

**COMMON GATE CHARACTERISTICS  
S-PARAMETERS**

( $V_{DS} = 15 \text{ Vdc}$ ,  $T_{channel} = 25^\circ\text{C}$ , Data Points in MHz)

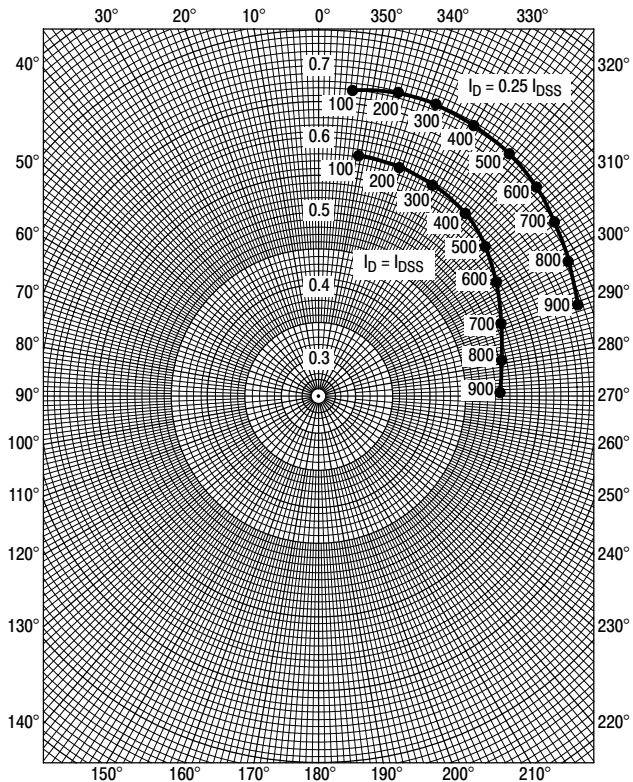

Figure 13.  $S_{11g}$

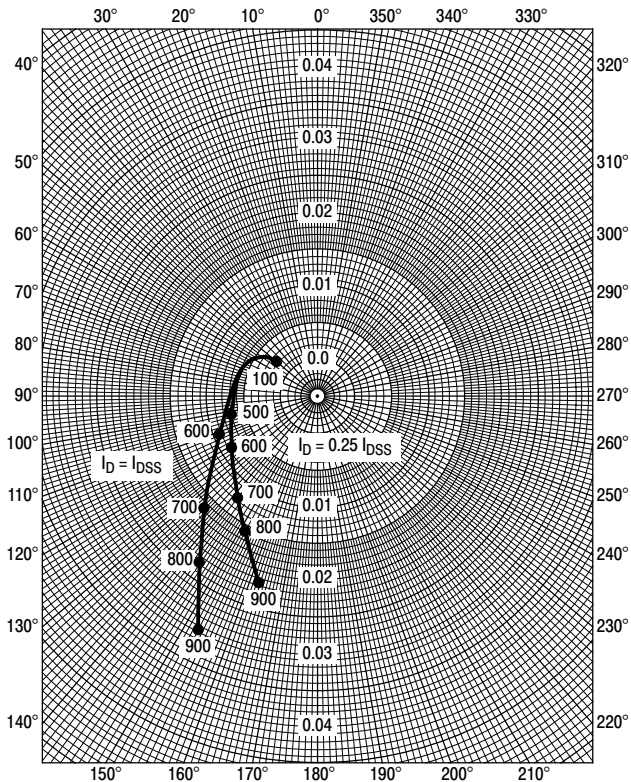

Figure 14.  $S_{12g}$

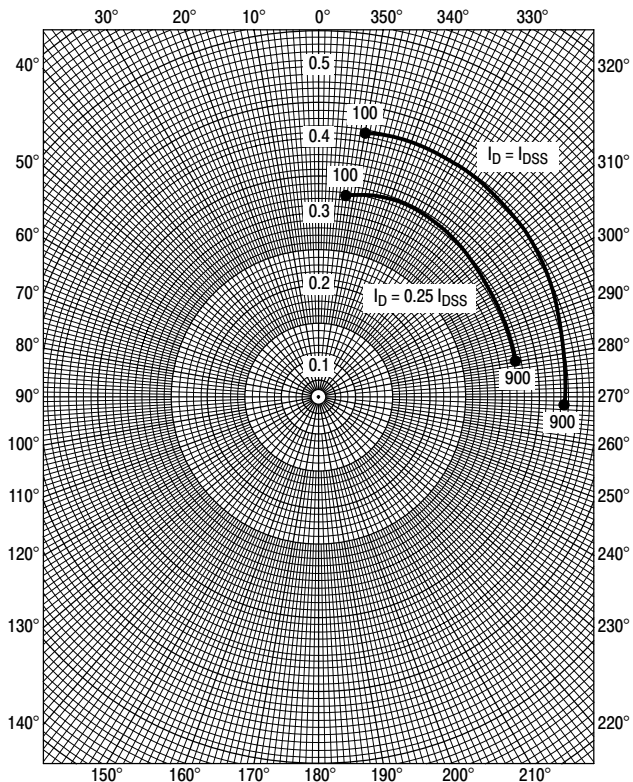

Figure 15.  $S_{21a}$

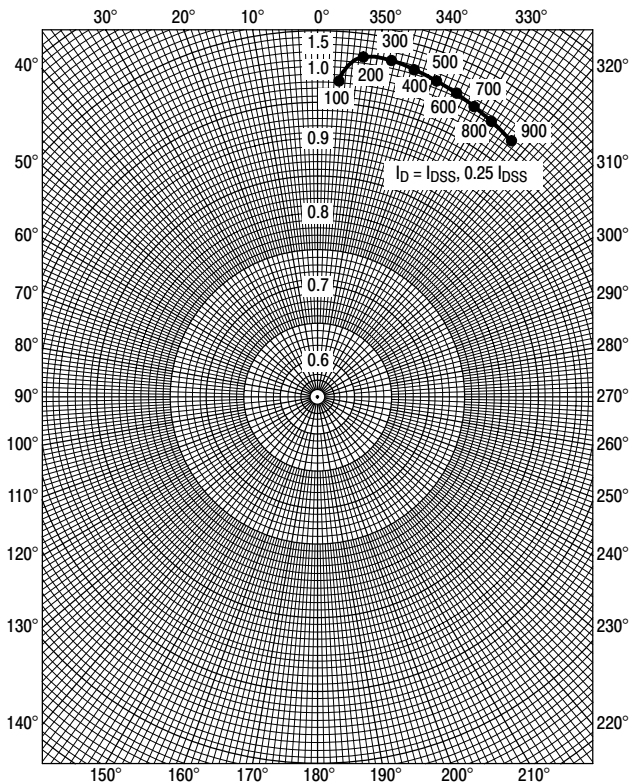
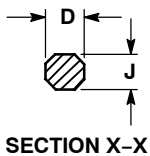
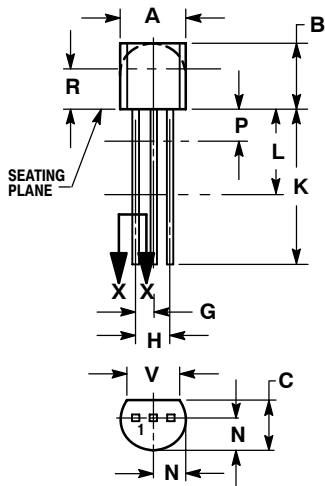

Figure 16.  $S_{22a}$

# 2N5486

## PACKAGE DIMENSIONS

### TO-92 (TO-226AA) CASE 29-11 ISSUE AL



STYLE 5:  
PIN 1. DRAIN  
2. SOURCE  
3. GATE

#### NOTES:

1. DIMENSIONING AND TOLERANCING PER ANSI Y14.5M, 1982.
2. CONTROLLING DIMENSION: INCH.
3. CONTOUR OF PACKAGE BEYOND DIMENSION R IS UNCONTROLLED.
4. LEAD DIMENSION IS UNCONTROLLED IN P AND BEYOND DIMENSION K MINIMUM.

DIM	INCHES		MILLIMETERS	
	MIN	MAX	MIN	MAX
A	0.175	0.205	4.45	5.20
B	0.170	0.210	4.32	5.33
C	0.125	0.165	3.18	4.19
D	0.016	0.021	0.407	0.533
G	0.045	0.055	1.15	1.39
H	0.095	0.105	2.42	2.66
J	0.015	0.020	0.39	0.50
K	0.500	---	12.70	---
L	0.250	---	6.35	---
N	0.080	0.105	2.04	2.66
P	---	0.100	---	2.54
R	0.115	---	2.93	---
V	0.135	---	3.43	---

# Notes

**ON Semiconductor** and **ON** are registered trademarks of Semiconductor Components Industries, LLC (SCILLC). SCILLC reserves the right to make changes without further notice to any products herein. SCILLC makes no warranty, representation or guarantee regarding the suitability of its products for any particular purpose, nor does SCILLC assume any liability arising out of the application or use of any product or circuit, and specifically disclaims any and all liability, including without limitation special, consequential or incidental damages. "Typical" parameters which may be provided in SCILLC data sheets and/or specifications can and do vary in different applications and actual performance may vary over time. All operating parameters, including "Typicals" must be validated for each customer application by customer's technical experts. SCILLC does not convey any license under its patent rights nor the rights of others. SCILLC products are not designed, intended, or authorized for use as components in systems intended for surgical implant into the body, or other applications intended to support or sustain life, or for any other application in which the failure of the SCILLC product could create a situation where personal injury or death may occur. Should Buyer purchase or use SCILLC products for any such unintended or unauthorized application, Buyer shall indemnify and hold SCILLC and its officers, employees, subsidiaries, affiliates, and distributors harmless against all claims, costs, damages, and expenses, and reasonable attorney fees arising out of, directly or indirectly, any claim of personal injury or death associated with such unintended or unauthorized use, even if such claim alleges that SCILLC was negligent regarding the design or manufacture of the part. SCILLC is an Equal Opportunity/Affirmative Action Employer. This literature is subject to all applicable copyright laws and is not for resale in any manner.

## PUBLICATION ORDERING INFORMATION

### LITERATURE FULFILLMENT:

Literature Distribution Center for ON Semiconductor  
P.O. Box 61312, Phoenix, Arizona 85082-1312 USA  
**Phone:** 480-829-7710 or 800-344-3860 Toll Free USA/Canada  
**Fax:** 480-829-7709 or 800-344-3867 Toll Free USA/Canada  
**Email:** [orderlit@onsemi.com](mailto:orderlit@onsemi.com)

**N. American Technical Support:** 800-282-9855 Toll Free  
USA/Canada

**Japan:** ON Semiconductor, Japan Customer Focus Center  
2-9-1 Kamimeguro, Meguro-ku, Tokyo, Japan 153-0051  
**Phone:** 81-3-5773-3850

**ON Semiconductor Website:** <http://onsemi.com>

**Order Literature:** <http://www.onsemi.com/litorder>

For additional information, please contact your local Sales Representative.