

# Amplifier Transistor

## NPN Silicon

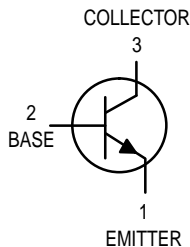
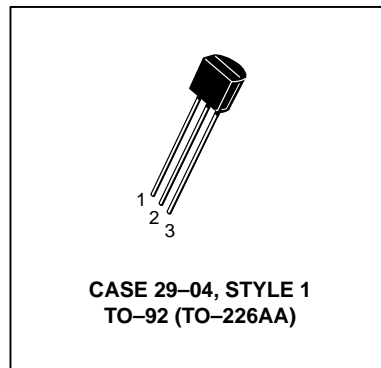
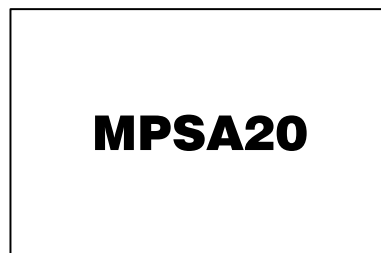

### MAXIMUM RATINGS

Rating	Symbol	Value	Unit
Collector–Emitter Voltage	$V_{CEO}$	40	Vdc
Collector–Base Voltage	$V_{CBO}$	4.0	Vdc
Collector Current — Continuous	$I_C$	100	mAdc
Total Device Dissipation @ $T_A = 25^\circ\text{C}$ Derate above $25^\circ\text{C}$	$P_D$	625 5.0	mW mW/ $^\circ\text{C}$
Total Device Dissipation @ $T_C = 25^\circ\text{C}$ Derate above $25^\circ\text{C}$	$P_D$	1.5 12	Watts mW/ $^\circ\text{C}$
Operating and Storage Junction Temperature Range	$T_J, T_{stg}$	-55 to +150	$^\circ\text{C}$

### THERMAL CHARACTERISTICS

Characteristic	Symbol	Max	Unit
Thermal Resistance, Junction to Ambient	$R_{\theta JA}^{(1)}$	200	$^\circ\text{C}/\text{W}$
Thermal Resistance, Junction to Case	$R_{\theta JC}$	83.3	$^\circ\text{C}/\text{W}$

### ELECTRICAL CHARACTERISTICS ( $T_A = 25^\circ\text{C}$ unless otherwise noted)

Characteristic	Symbol	Min	Max	Unit
----------------	--------	-----	-----	------

### OFF CHARACTERISTICS

Collector–Emitter Breakdown Voltage <sup>(2)</sup> ( $I_C = 1.0 \text{ mAdc}, I_B = 0$ )	$V_{(BR)CEO}$	40	—	Vdc
Emitter–Base Breakdown Voltage ( $I_E = 100 \mu\text{Adc}, I_C = 0$ )	$V_{(BR)EBO}$	4.0	—	Vdc
Collector Cutoff Current ( $V_{CB} = 30 \text{ Vdc}, I_E = 0$ )	$I_{CBO}$	—	100	nAdc

- $R_{\theta JA}$  is measured with the device soldered into a typical printed circuit board.
- Pulse Test: Pulse Width  $\leq 300 \mu\text{s}$ , Duty Cycle  $\leq 2.0\%$ .

## MPSA20

### ELECTRICAL CHARACTERISTICS ( $T_A = 25^\circ\text{C}$ unless otherwise noted) (Continued)

Characteristic	Symbol	Min	Max	Unit
<b>ON CHARACTERISTICS</b>				
DC Current Gain <sup>(2)</sup> ( $I_C = 5.0 \text{ mAdc}$ , $V_{CE} = 10 \text{ Vdc}$ )	$h_{FE}$	40	400	—
Collector–Emitter Saturation Voltage ( $I_C = 10 \text{ mAdc}$ , $I_B = 1.0 \text{ mAdc}$ )	$V_{CE(sat)}$	—	0.25	Vdc
<b>SMALL–SIGNAL CHARACTERISTICS</b>				
Current–Gain — Bandwidth Product <sup>(2)</sup> ( $I_C = 5.0 \text{ mAdc}$ , $V_{CE} = 10 \text{ Vdc}$ , $f = 100 \text{ MHz}$ )	$f_T$	125	—	MHz
Output Capacitance ( $V_{CB} = 10 \text{ Vdc}$ , $I_E = 0$ , $f = 1.0 \text{ MHz}$ )	$C_{obo}$	—	4.0	pF

2. Pulse Test: Pulse Width  $\leq 300 \mu\text{s}$ , Duty Cycle  $\leq 2.0\%$ .

### EQUIVALENT SWITCHING TIME TEST CIRCUITS

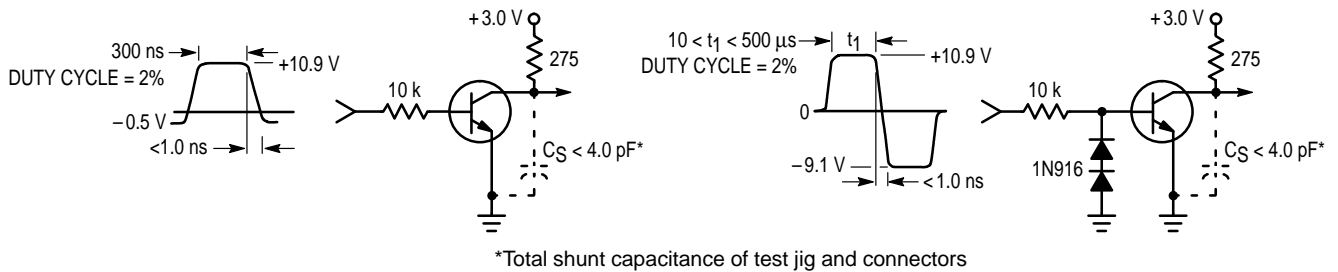
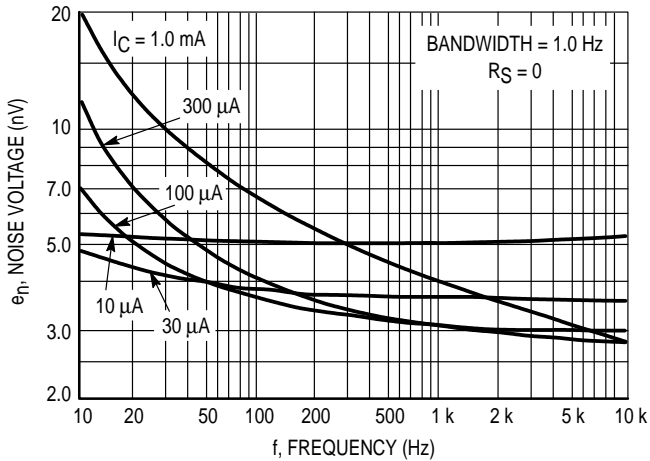

Figure 1. Turn–On Time

Figure 2. Turn–Off Time

**TYPICAL NOISE CHARACTERISTICS**

( $V_{CE} = 5.0 \text{ Vdc}$ ,  $T_A = 25^\circ\text{C}$ )



**Figure 3. Noise Voltage**

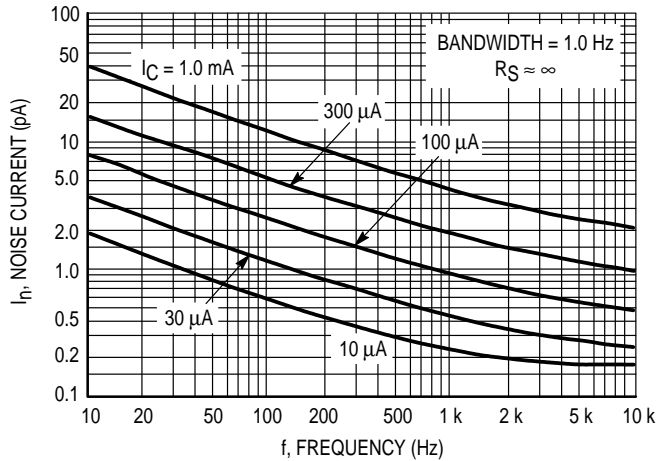

**Figure 4. Noise Current**

**NOISE FIGURE CONTOURS**

( $V_{CE} = 5.0 \text{ Vdc}$ ,  $T_A = 25^\circ\text{C}$ )

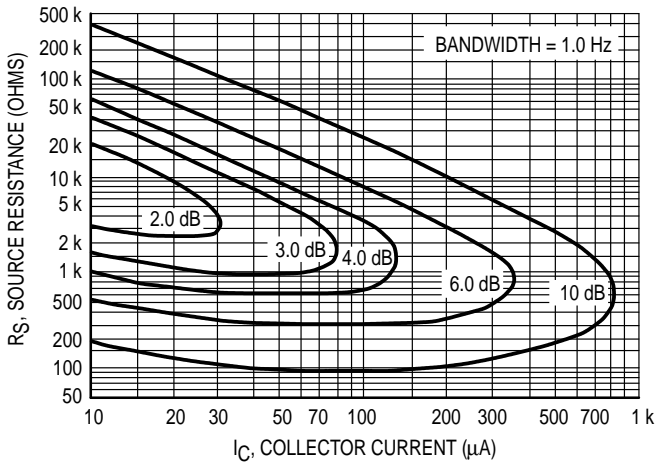

**Figure 5. Narrow Band, 100 Hz**

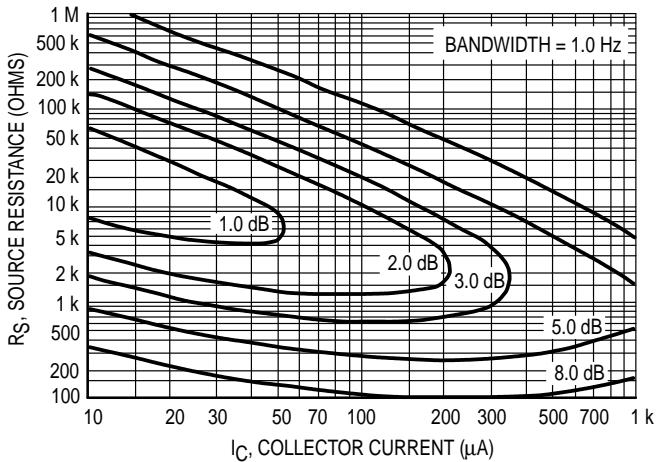

**Figure 6. Narrow Band, 1.0 kHz**

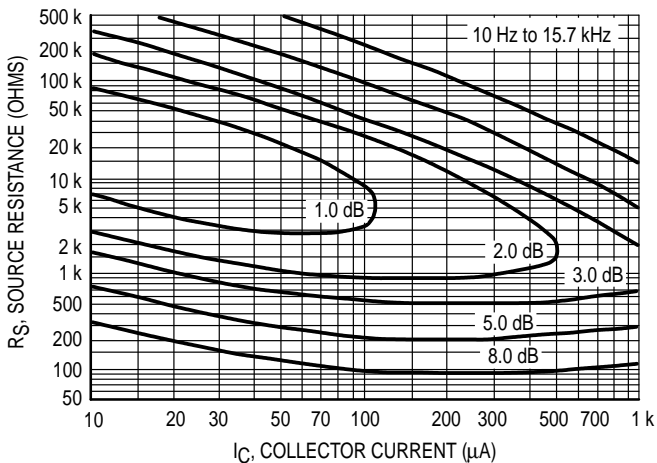

**Figure 7. Wideband**

Noise Figure is defined as:

$$NF = 20 \log_{10} \left( \frac{e_n^2 + 4KTR_S + I_n^2 R_S^2}{4KTR_S} \right)^{1/2}$$

- $e_n$  = Noise Voltage of the Transistor referred to the input. (Figure 3)
- $I_n$  = Noise Current of the Transistor referred to the input. (Figure 4)
- $K$  = Boltzman's Constant ( $1.38 \times 10^{-23} \text{ J}^\circ\text{K}$ )
- $T$  = Temperature of the Source Resistance ( $^\circ\text{K}$ )
- $R_S$  = Source Resistance (Ohms)

**TYPICAL STATIC CHARACTERISTICS**

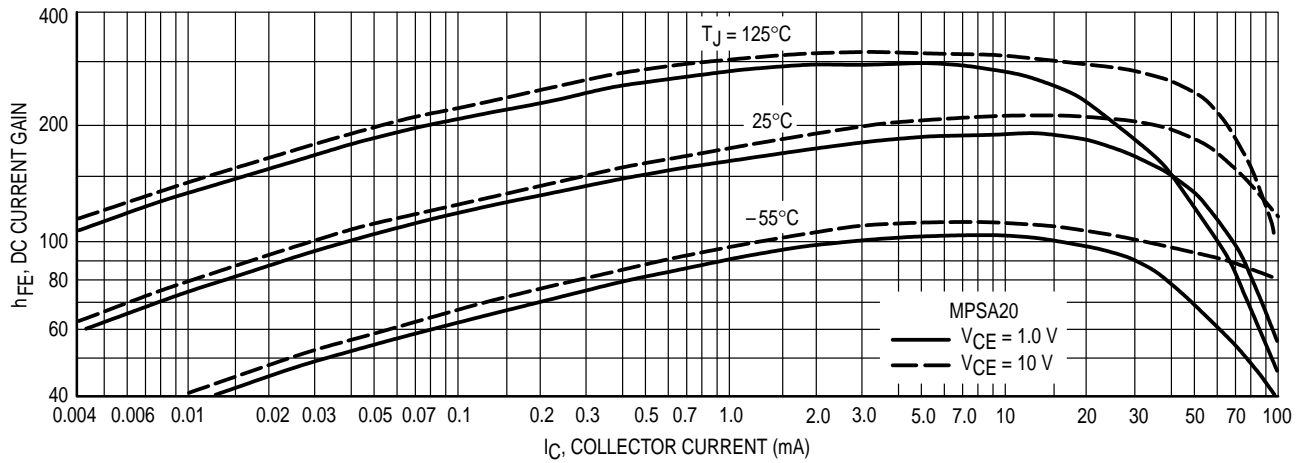

**Figure 8. DC Current Gain**

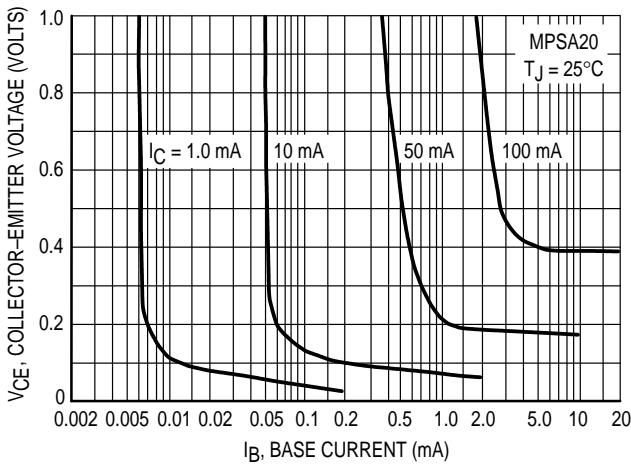

**Figure 9. Collector Saturation Region**

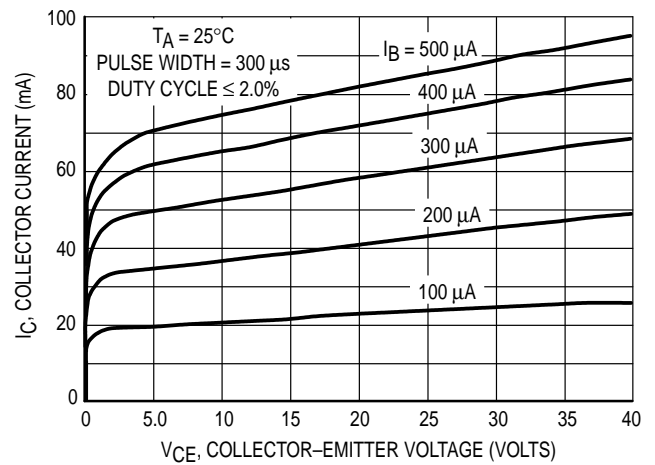

**Figure 10. Collector Characteristics**

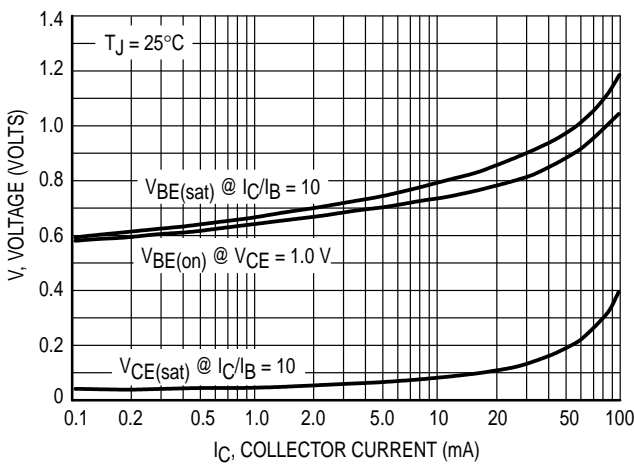

**Figure 11. "On" Voltages**

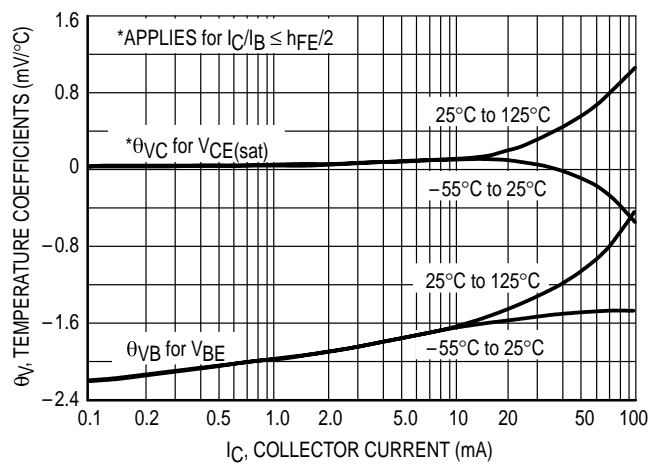

**Figure 12. Temperature Coefficients**

TYPICAL DYNAMIC CHARACTERISTICS

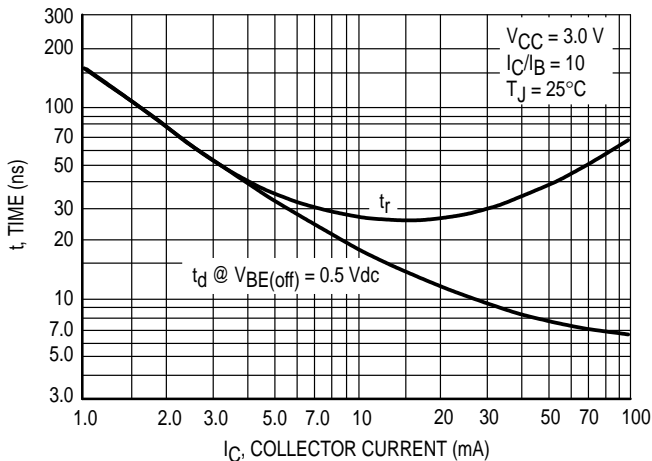

Figure 13. Turn-On Time

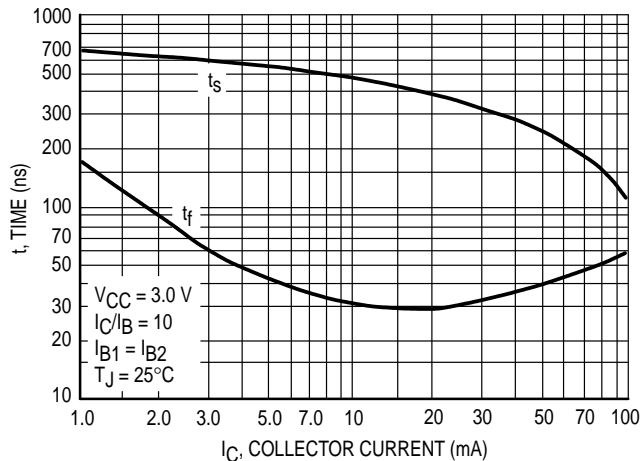

Figure 14. Turn-Off Time

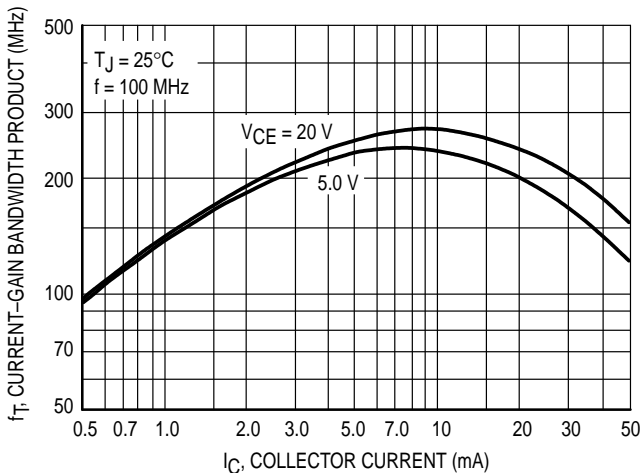

Figure 15. Current-Gain — Bandwidth Product

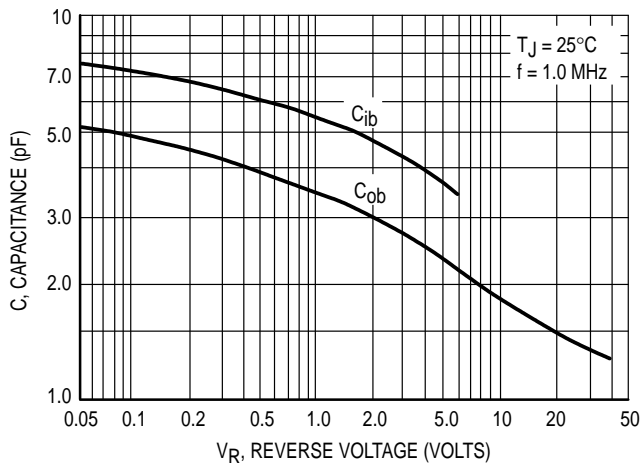

Figure 16. Capacitance

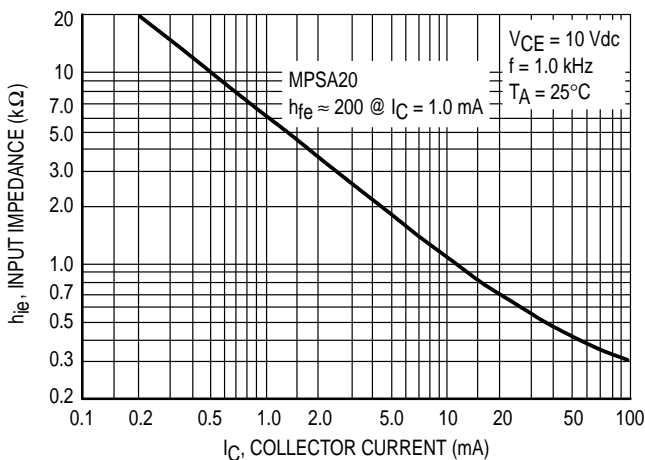

Figure 17. Input Impedance

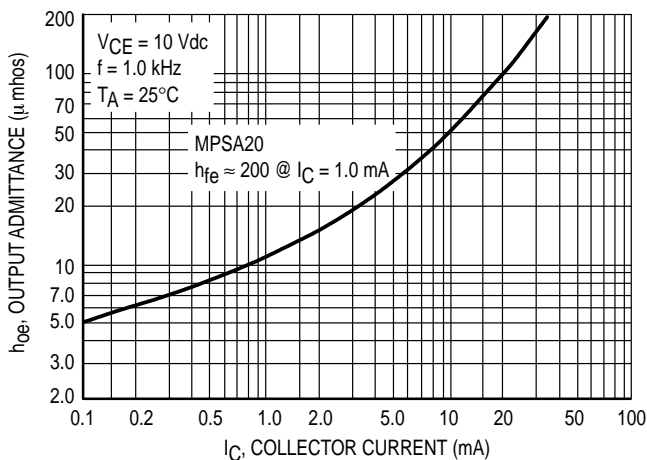
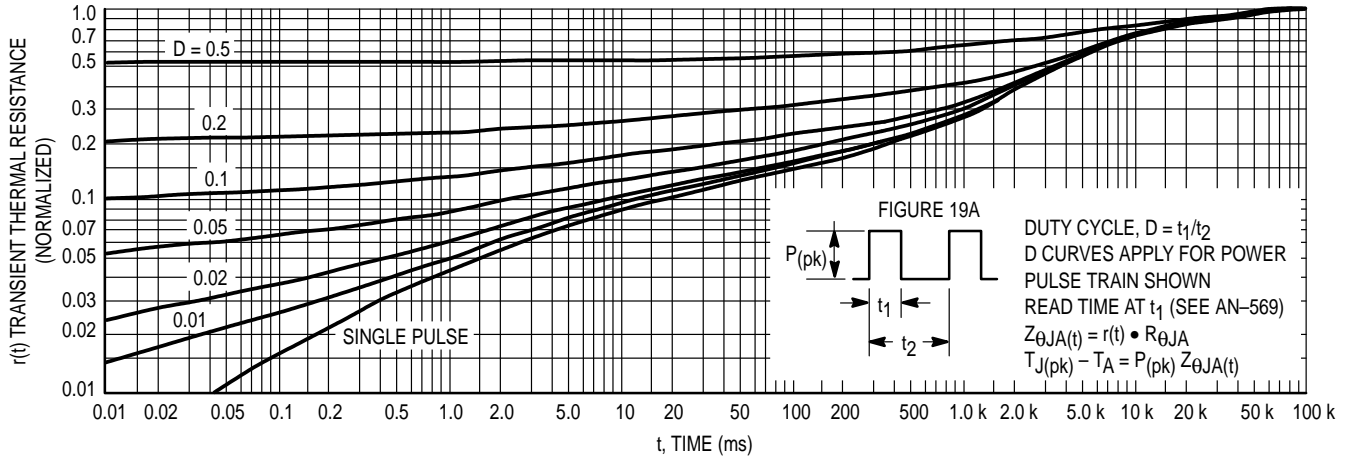
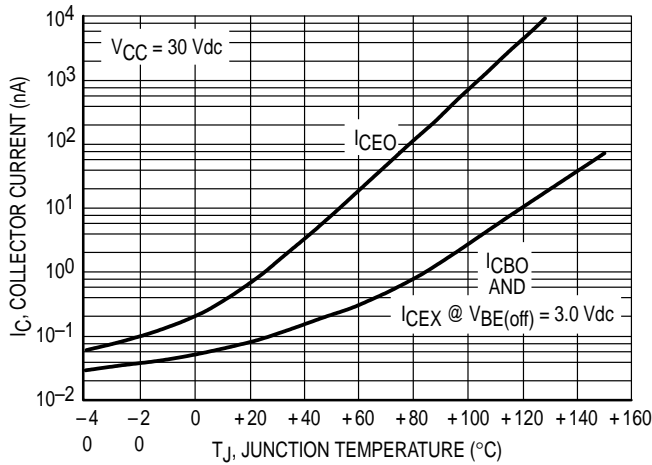

Figure 18. Output Admittance

**MPSA20**



**Figure 19. Thermal Response**



**Figure 19A.**

**DESIGN NOTE: USE OF THERMAL RESPONSE DATA**

A train of periodical power pulses can be represented by the model as shown in Figure 19A. Using the model and the device thermal response the normalized effective transient thermal resistance of Figure 19 was calculated for various duty cycles.

To find  $Z_{\theta JA}(t)$ , multiply the value obtained from Figure 19 by the steady state value  $R_{\theta JA}$ .

Example:

Dissipating 2.0 watts peak under the following conditions:

$t_1 = 1.0$  ms,  $t_2 = 5.0$  ms. ( $D = 0.2$ )

Using Figure 19 at a pulse width of 1.0 ms and  $D = 0.2$ , the reading of  $r(t)$  is 0.22.

The peak rise in junction temperature is therefore

$$\Delta T = r(t) \times P_{(pk)} \times R_{\theta JA} = 0.22 \times 2.0 \times 200 = 88^\circ\text{C}.$$

For more information, see AN-569.

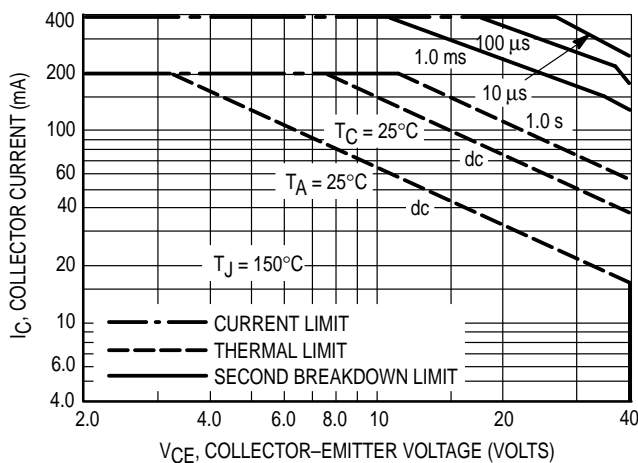
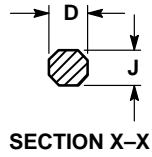
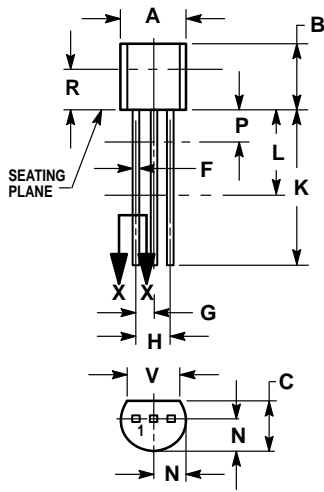

**Figure 20.**

The safe operating area curves indicate  $I_C$ - $V_{CE}$  limits of the transistor that must be observed for reliable operation. Collector load lines for specific circuits must fall below the limits indicated by the applicable curve.

The data of Figure 20 is based upon  $T_{J(pk)} = 150^\circ\text{C}$ ;  $T_C$  or  $T_A$  is variable depending upon conditions. Pulse curves are valid for duty cycles to 10% provided  $T_{J(pk)} \leq 150^\circ\text{C}$ .  $T_{J(pk)}$  may be calculated from the data in Figure 19. At high case or ambient temperatures, thermal limitations will reduce the power that can be handled to values less than the limitations imposed by second breakdown.

PACKAGE DIMENSIONS



**CASE 029-04  
(TO-226AA)  
ISSUE AD**

NOTES:

1. DIMENSIONING AND TOLERANCING PER ANSI Y14.5M, 1982.
2. CONTROLLING DIMENSION: INCH.
3. CONTOUR OF PACKAGE BEYOND DIMENSION R IS UNCONTROLLED.
4. DIMENSION F APPLIES BETWEEN P AND L. DIMENSION D AND J APPLY BETWEEN L AND K. MINIMUM LEAD DIMENSION IS UNCONTROLLED IN P AND BEYOND DIMENSION K MINIMUM.

DIM	INCHES		MILLIMETERS	
	MIN	MAX	MIN	MAX
A	0.175	0.205	4.45	5.20
B	0.170	0.210	4.32	5.33
C	0.125	0.165	3.18	4.19
D	0.016	0.022	0.41	0.55
F	0.016	0.019	0.41	0.48
G	0.045	0.055	1.15	1.39
H	0.095	0.105	2.42	2.66
J	0.015	0.020	0.39	0.50
K	0.500	—	12.70	—
L	0.250	—	6.35	—
N	0.080	0.105	2.04	2.66
P	—	0.100	—	2.54
R	0.115	—	2.93	—
V	0.135	—	3.43	—

STYLE 1:

- PIN 1. EMITTER
2. BASE
3. COLLECTOR

Motorola reserves the right to make changes without further notice to any products herein. Motorola makes no warranty, representation or guarantee regarding the suitability of its products for any particular purpose, nor does Motorola assume any liability arising out of the application or use of any product or circuit, and specifically disclaims any and all liability, including without limitation consequential or incidental damages. "Typical" parameters which may be provided in Motorola data sheets and/or specifications can and do vary in different applications and actual performance may vary over time. All operating parameters, including "Typicals" must be validated for each customer application by customer's technical experts. Motorola does not convey any license under its patent rights nor the rights of others. Motorola products are not designed, intended, or authorized for use as components in systems intended for surgical implant into the body, or other applications intended to support or sustain life, or for any other application in which the failure of the Motorola product could create a situation where personal injury or death may occur. Should Buyer purchase or use Motorola products for any such unintended or unauthorized application, Buyer shall indemnify and hold Motorola and its officers, employees, subsidiaries, affiliates, and distributors harmless against all claims, costs, damages, and expenses, and reasonable attorney fees arising out of, directly or indirectly, any claim of personal injury or death associated with such unintended or unauthorized use, even if such claim alleges that Motorola was negligent regarding the design or manufacture of the part. Motorola and  are registered trademarks of Motorola, Inc. Motorola, Inc. is an Equal Opportunity/Affirmative Action Employer.

**How to reach us:**

**USA/EUROPE/Locations Not Listed:** Motorola Literature Distribution;  
P.O. Box 20912; Phoenix, Arizona 85036. 1-800-441-2447 or 602-303-5454

**JAPAN:** Nippon Motorola Ltd.; Tatsumi-SPD-JLDC, 6F Seibu-Butsuryu-Center,  
3-14-2 Tatsumi Koto-Ku, Tokyo 135, Japan. 03-81-3521-8315

**MFAX:** RMFAX0@email.sps.mot.com – TOUCHTONE 602-244-6609  
**INTERNET:** <http://Design-NET.com>

**ASIA/PACIFIC:** Motorola Semiconductors H.K. Ltd.; 8B Tai Ping Industrial Park,  
51 Ting Kok Road, Tai Po, N.T., Hong Kong. 852-26629298





This datasheet has been download from:

[www.datasheetcatalog.com](http://www.datasheetcatalog.com)

Datasheets for electronics components.